

08 | LINEAR MOTION

SHIMLESS INDUSTRIAL LINEAR BEARINGS

Shimless Industrial Linear Bearings are designed to be used in both low and high acceleration/deceleration applications. The Shimless Industrial Linear Bearing contains special threaded inserts in the pads that allow for a more heavy duty bearing. The Shimless Industrial Linear Bearings can be used in applications such as actuators, parts transfers, or pick and place operations.

ADVANTAGES OF THE SHIMLESS INDUSTRIAL LINEAR BEARING ARE:

1. Added radii increases structural strength of extrusion housing, and smooth clean finish.
2. Shimless Industrial Bearings provide convenience and single tool adjustability without disassembly.
3. Full length bearing pads on all bearings.
4. Due to type of fasteners provided, all bearings are designed for Industrial (hi-cycle, long life) use.
5. Can install L-handle brake for positioning.
6. Eliminate adjustability of bearing by using shim pack.

Linear Motion

10 SERIES SINGLE FLANGE LINEAR BEARINGS ^{10S} ^{25S}



ITEM #	DESCRIPTION
657055	10 Series Single Flange Linear Bearings
657056	10 Series Single Flange Linear Bearings Long

RECOMMENDED FASTENERS

651236 1/4-20 x 5/8" SHCS & Economy T-Nut

» See page 08:17 for Linear Bearing Assembly and Adjustment Instructions.

» See page 08:18 for recommended load ratings.

ITEM #	A	B	C	D	E	F	G	H	J	K	L	M	N	P	Q	R	S	T	U*
657055	1.00	.306	1.701	.403	1.007	1.757	2.16	.75	.312	.831	.507	1.41	1.88	.438	1.00	N/A	N/A	.375	.097
657056	1.00	.306	1.701	.403	1.007	1.757	2.16	.75	.312	.831	.507	1.41	4.00	.500	1.00	1.00	1.00	.375	.097

* Add 1.00" when using 1020 extrusion.

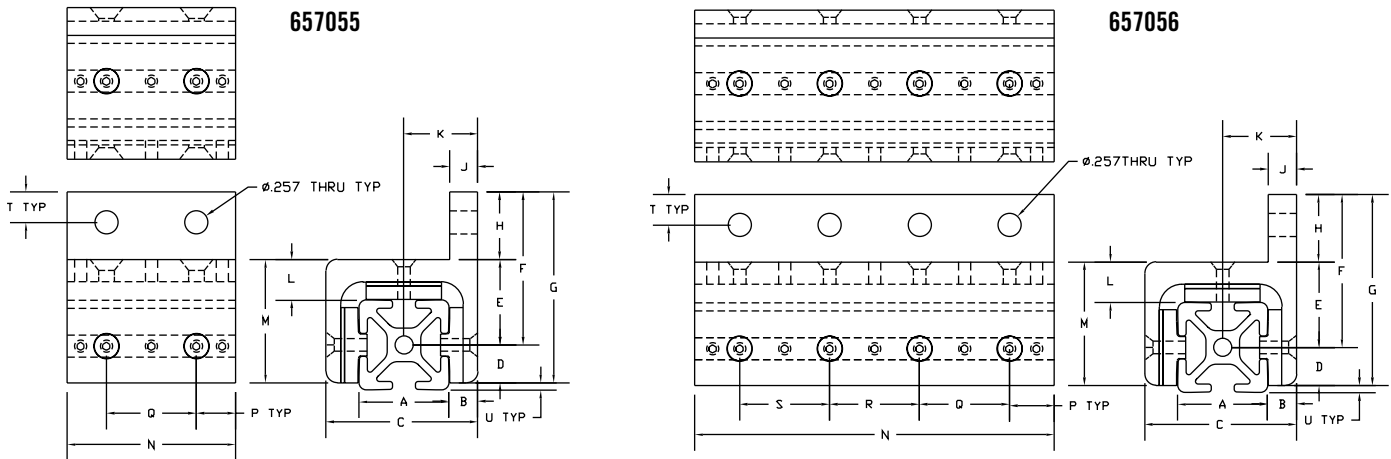

10 SERIES DOUBLE FLANGE LINEAR BEARINGS ^(10S) ^(25S)



ITEM #	DESCRIPTION
657059	10 Series Double Flange Linear Bearings
657060	10 Series Double Flange Linear Bearings Long

RECOMMENDED FASTENERS

651236 1/4-20 x 5/8" SHCS & Economy T-Nut

» See page 08:17 for Linear Bearing Assembly and Adjustment Instructions.

» See page 08:18 for recommended load ratings.

ITEM #	A	B	C	D	E	F	G	H	J	K	L	M	N	P	Q	R	S	T	U*
657059	1.00	.306	1.701	.403	.913	.312	3.26	.780	2.50	1.61	1.316	1.004	1.88	.438	1.00	N/A	N/A	.360	.097
657060	1.00	.306	1.701	.403	.913	.312	3.26	.780	2.50	1.61	1.316	1.004	4.00	.500	1.00	1.00	1.00	.360	.097

* Add 1.00" when using 1020 extrusion.

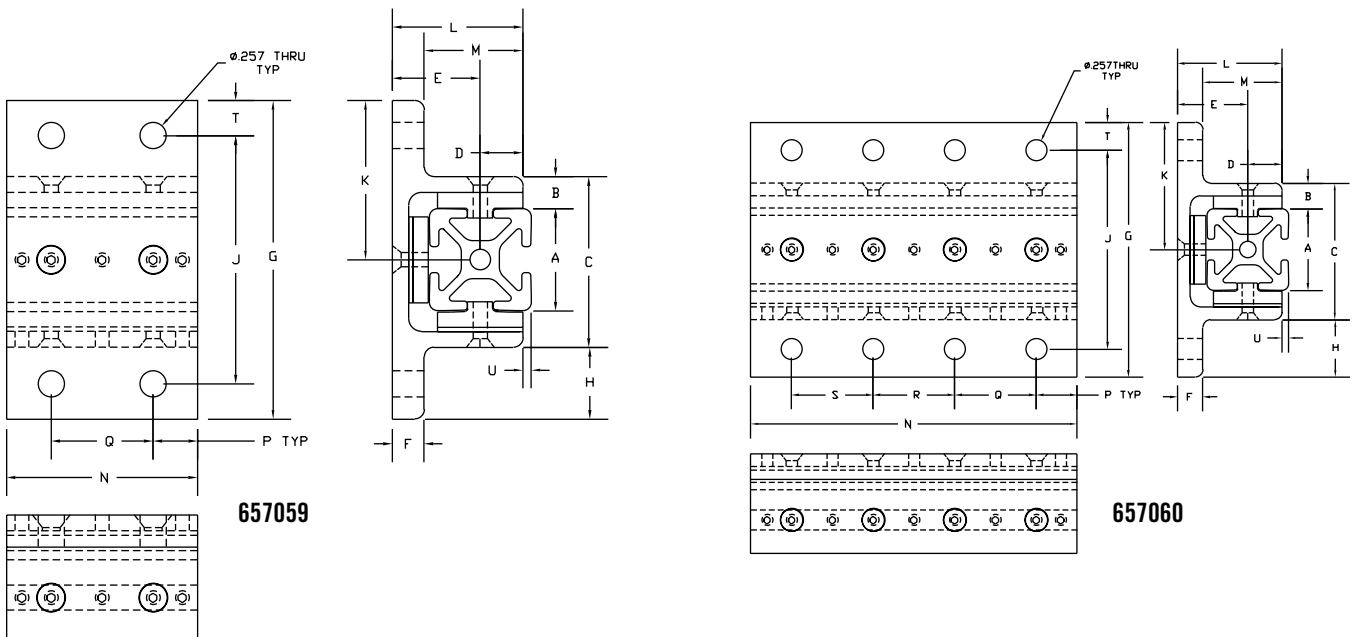

Linear Motion

10 SERIES DOUBLE FLANGE LINEAR BEARINGS 10S 25S



ITEM #	DESCRIPTION
657057	10 Series Double Flange Linear Bearings
657058	10 Series Double Flange Linear Bearings Long

RECOMMENDED FASTENERS

651236 1/4-20 x 5/8" SHCS & Economy T-Nut

» See page 08:17 for Linear Bearing Assembly and Adjustment Instructions.

» See page 08:18 for recommended load ratings.

ITEM #	A	B	C	D	E	F	G	H	J	K	L	M	N	P	Q	R	S	T	U*	V
657055	2.00	0.306	2.707	0.403	0.913	0.312	4.25	0.772	3.49	1.61	1.316	1.004	1.88	0.438	1.00	N/A	N/A	0.36	0.097	1.00
657058	2.00	0.306	2.707	0.403	0.913	0.312	4.25	0.772	3.49	1.61	1.316	1.004	4.00	0.500	1.00	1.00	1.00	0.36	0.097	1.00

* Add 1.00" when using 2020 extrusion.

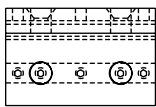

657057

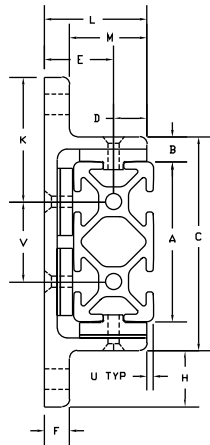
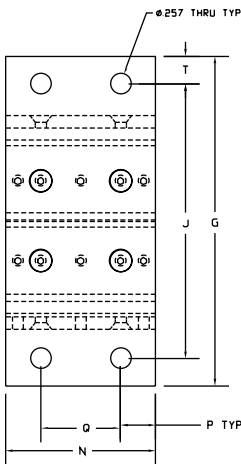

657058

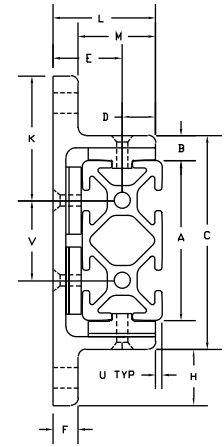
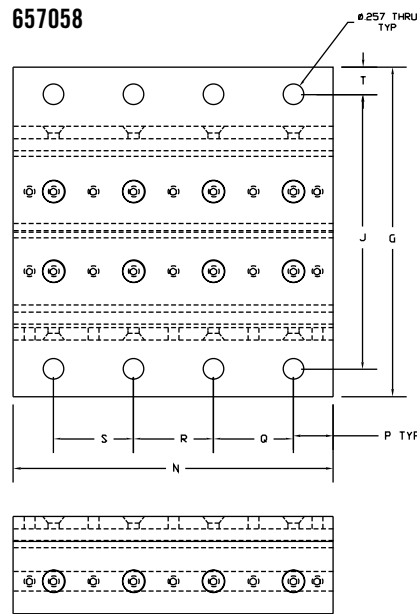

15 SERIES SINGLE FLANGE LINEAR BEARINGS ^{15S}



ITEM #	DESCRIPTION
657092	15 Series Single Flange Linear Bearings
657093	15 Series Single Flange Linear Bearings Long

RECOMMENDED FASTENERS

651059 & 651097 5/16-18 x 1" SHCS & Economy T-Nut

» See page 08:17 for Linear Bearing Assembly and Adjustment Instructions.

» See page 08:18 for recommended load ratings.

ITEM #	A	B	C	D	E	F	G	H	J	K	L	M	N	P	Q	R	S	T	U*
657092	1.50	.490	2.60	.620	1.44	2.19	2.818	.750	.500	1.275	.690	2.068	2.81	.656	1.50	N/A	N/A	.375	.130
657093	1.50	.490	2.60	.620	1.44	2.19	2.818	.750	.500	1.275	.690	2.068	6.00	.75	1.50	1.50	1.50	.375	.130

* Add 1.50" when using the 1530 / 1530L extrusions or 3.00" when using the 1545 extrusion.

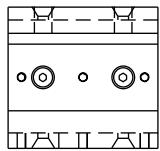

657092

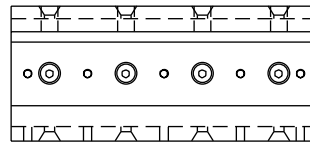

657093

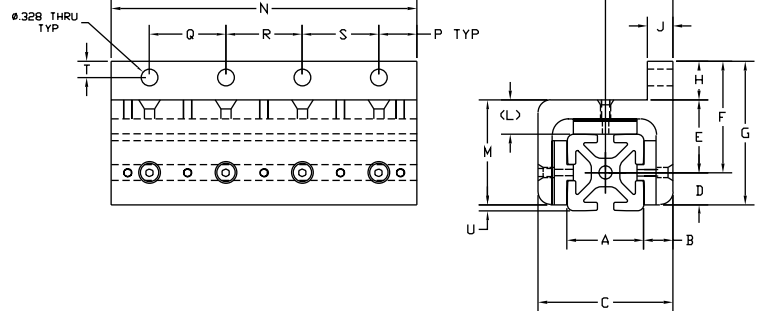
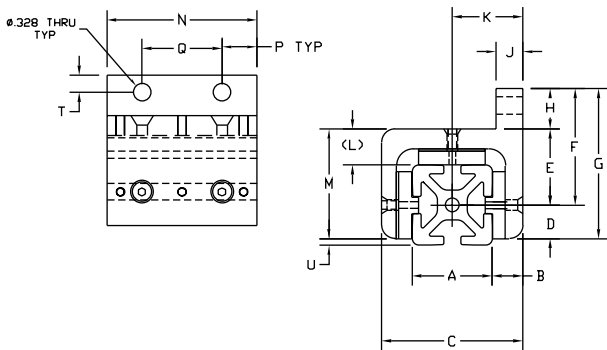

Linear Motion

15 SERIES DOUBLE FLANGE LINEAR BEARINGS ^{15S}



ITEM #	DESCRIPTION
657097	15 Series Double Flange Linear Bearings
657098	15 Series Double Flange Linear Bearings Long

RECOMMENDED FASTENERS

651205 5/16-18 x 7/8" SHCS & Economy T-Nut

» See page 08:17 for Linear Bearing Assembly and Adjustment Instructions.

» See page 08:18 for recommended load ratings.

ITEM #	A	B	C	D	E	F	G	H	J	K	L	M	N	P	Q	R	S	T	U*
657097	1.50	.490	2.60	.62	1.323	.375	4.50	.95	3.50	2.225	1.943	1.568	2.81	.656	1.50	N/A	N/A	.475	.130
657098	1.50	.490	2.60	.62	1.323	.375	4.50	.95	3.50	2.225	1.943	1.568	6.00	.75	1.50	1.50	1.50	.475	.130

* Add 1.50" when using 1530 / 1530L extrusions or 3.00" when using the 1545 extrusion.

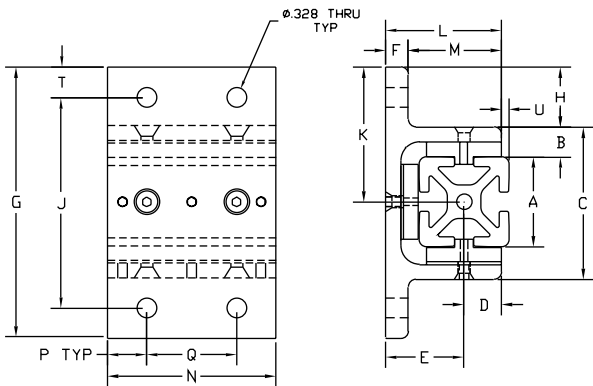

657097

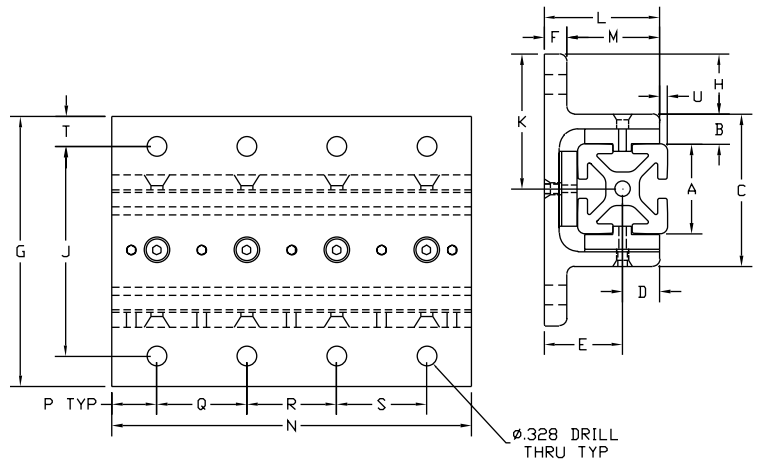
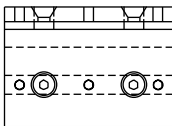

657098

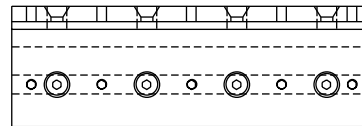

15 SERIES DOUBLE FLANGE LINEAR BEARINGS ^{15S}



ITEM #	DESCRIPTION
657095	15 Series Double Flange Linear Bearings
657096	15 Series Double Flange Linear Bearings Long

RECOMMENDED FASTENERS

651205 5/16-18 x 7/8" SHCS & Economy T-Nut

» See page 08:17 for Linear Bearing Assembly and Adjustment Instructions.

» See page 08:18 for recommended load ratings.

ITEM #	A	B	C	D	E	F	G	H	J	K	L	M	N	P	Q	R	S	T	U*	V
657095	3.00	0.49	4.10	0.62	1.323	0.375	6.00	0.95	5.00	2.25	1.943	1.568	2.81	0.656	1.50	N/A	N/A	0.475	0.13	1.50
657096	3.00	0.49	4.10	0.62	1.323	0.375	6.00	0.95	5.00	2.25	1.943	1.568	6.00	0.750	1.50	1.50	1.50	0.475	0.13	1.50

* Add 1.00" when using 2020 extrusion.

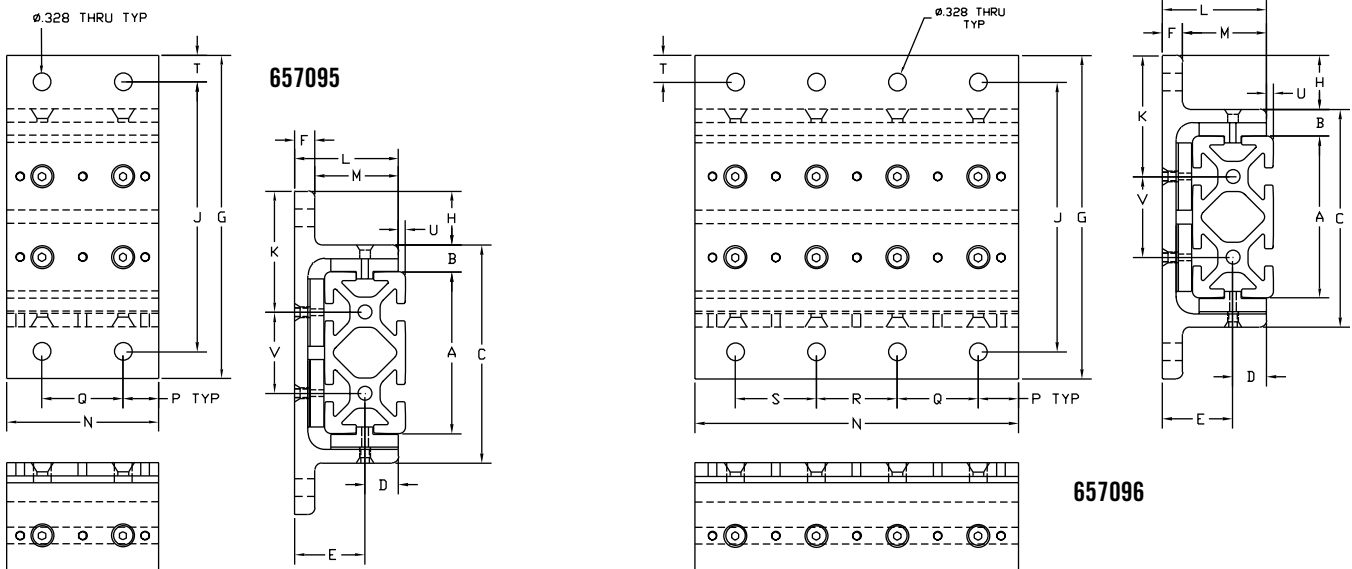

Linear Motion

10 SERIES ECONOMY SINGLE FLANGE LINEAR BEARINGS 10S 25S



657150



657151

ITEM #	DESCRIPTION
657150	10 Series Economy Short Flange Linear Bearing
657151	10 Series Economy Long Flange Linear Bearing

RECOMMENDED FASTENERS

651236 1/4-20 x 5/8" SHCS & Economy T-Nut

» See page 08:18 for recommended load ratings.

ITEM #	657150	657151
A	1.00	1.00
B	.312	.312
C	1.625	1.625
D	.406	.406
E	.903	.903
F	1.562	1.562
G	1.968	1.968
H	.656	.656
J	.312	.312
K	.813	.813
L	.406	.406
M	1.312	1.312
N	1.875	4.000
P	.438	.500
Q	1.000	1.000
R	N/A	1.000
S	N/A	1.000
T	.343	.343
U*	.094	.094

*Add 1" when using a 1" x 2" extrusion or 2" when using a 1" x 3" extrusion.

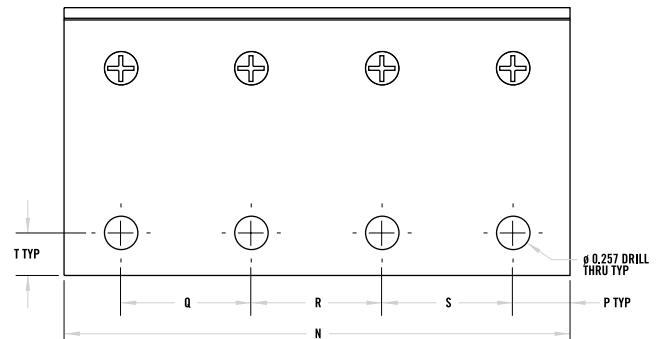
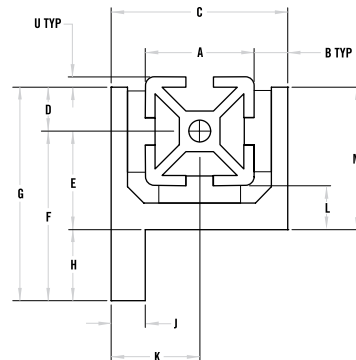

10 SERIES ECONOMY DOUBLE FLANGE LINEAR BEARINGS 10S 25S



657152



657153

ITEM #	DESCRIPTION
657152	10 Series Economy Short Double Flange Linear Bearing
657153	10 Series Economy Long Double Flange Linear Bearing

RECOMMENDED FASTENERS

651236 1/4-20 x 5/8" SHCS & Economy T-Nut

» See page 08:18 for recommended load ratings.

ITEM #	657152	657153
A	1.00	1.00
B	.312	.312
C	1.625	1.625
D	.406	.406
E	.812	.812
F	.312	.312
G	2.937	2.937
H	.656	.656
J	2.250	2.250
K	.812	.812
L	1.218	1.218
M	.906	.906
N	1.875	4.000
P	.438	.500
Q	1.000	1.000
R	N/A	1.000
S	N/A	1.000
T	.343	.343
U*	.094	.094

*Add 1" when using a 1" x 2" extrusion or 2" when using a 1" x 3" extrusion.

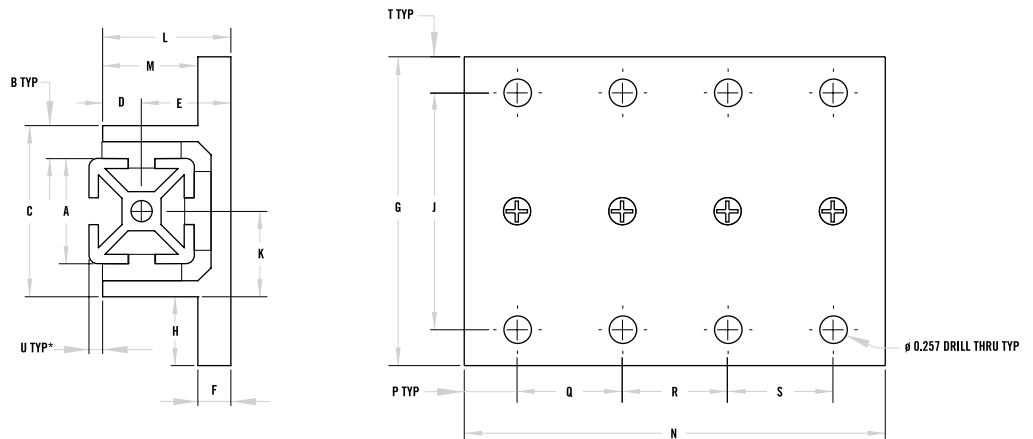

Linear Motion

08:10

10 SERIES ECONOMY DOUBLEWIDE FLANGE LINEAR BEARINGS 10S 25S



657154



657155

ITEM #	DESCRIPTION
657154	10 Series Economy Short Doublewide Flange Linear Bearing
657155	10 Series Economy Long Doublewide Flange Linear Bearing

RECOMMENDED FASTENERS

651236 1/4-20 x 5/8" SHCS & Economy T-Nut

» See page 08:18 for recommended load ratings.

ITEM #	657154	657155
A	2.00	2.00
B	.312	.312
C	2.63	2.63
D	.406	.406
E	.812	.812
F	.312	.312
G	3.937	3.937
H	.656	.656
J	3.250	3.250
K	.812	.812
L	1.218	1.218
M	.906	.906
N	1.875	4.00
P	.437	.500
Q	1.00	1.00
R	N/A	1.00
S	N/A	1.00
T	.343	.343
U*	.094	.094
V	1.00	1.00

*Add 1" when using a 2" x 2" extrusion or 3" when using a 2" x 4" extrusion.

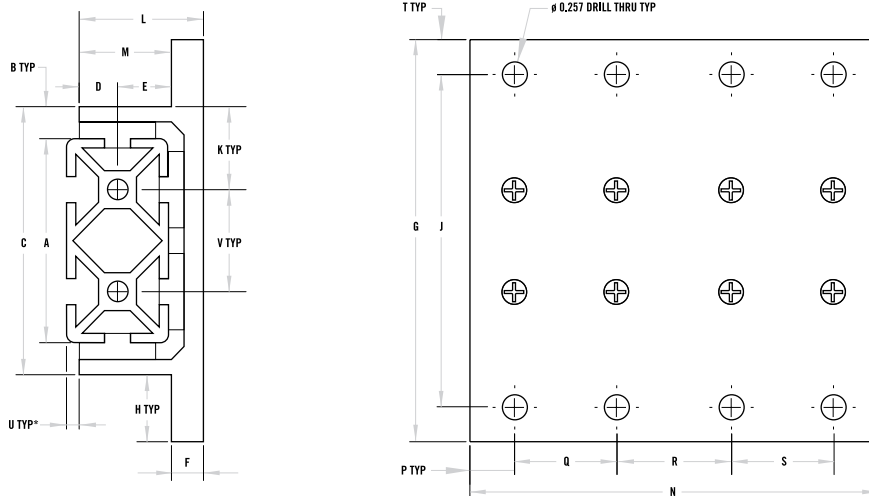

15 SERIES ECONOMY FLANGE LINEAR BEARINGS ^(15S)



657156



657157

ITEM #	DESCRIPTION
657156	15 Series Economy Short Flange Linear Bearing
657157	15 Series Economy Long Flange Linear Bearing

RECOMMENDED FASTENERS

651059 & 651097 5/16-18 x 1" SHCS & Economy T-Nut

» See page 08:18 for recommended load ratings.

ITEM #	657156	657157
A	1.50	1.50
B	.500	.500
C	2.50	2.50
D	.625	.625
E	1.375	1.375
F	2.125	2.125
G	2.75	2.75
H	.750	.750
J	.500	.500
K	1.25	1.25
L	.625	.625
M	2.00	2.00
N	2.182	6.00
P	.656	.750
Q	1.50	1.50
R	N/A	1.50
S	N/A	1.50
T	.375	.375
U*	.125	.125

*Add 1.5" when using a 1.5" x 3" extrusion or 3" when using a 1.5" x 4" extrusion.

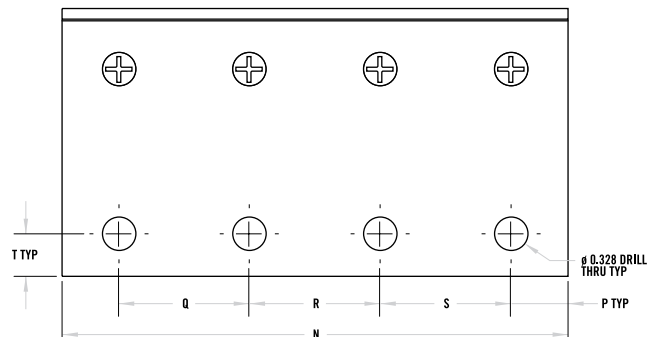
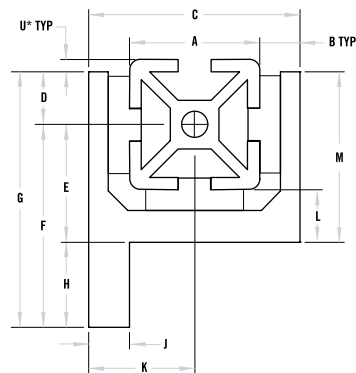

Linear Motion

08:12

15 SERIES ECONOMY DOUBLE FLANGE LINEAR BEARINGS ^{15S}



657148



657158

ITEM #	DESCRIPTION
657148	15 Series Economy Short Double Flange Linear Bearing
657158	15 Series Economy Long Double Flange Linear Bearing

RECOMMENDED FASTENERS

651205 5/16-18 x 7/8" SHCS & Economy T-Nut

» See page 08:18 for recommended load ratings.

ITEM #	657148	657158
A	1.500	1.500
B	.500	.500
C	2.500	2.500
D	.640	.640
E	1.235	1.235
F	.375	.375
G	4.000	4.000
H	.750	.750
J	3.250	3.250
K	1.250	1.250
L	1.875	1.875
M	1.500	1.500
N	2.312	6.000
P	.656	.750
Q	1.500	1.500
R	N/A	1.500
S	N/A	1.500
T	.375	.375
U*	.125	.125

*Add 1.50" when using a 1.5" x 3" extrusion or 3" when using a 1.5" x 4.5" extrusion.

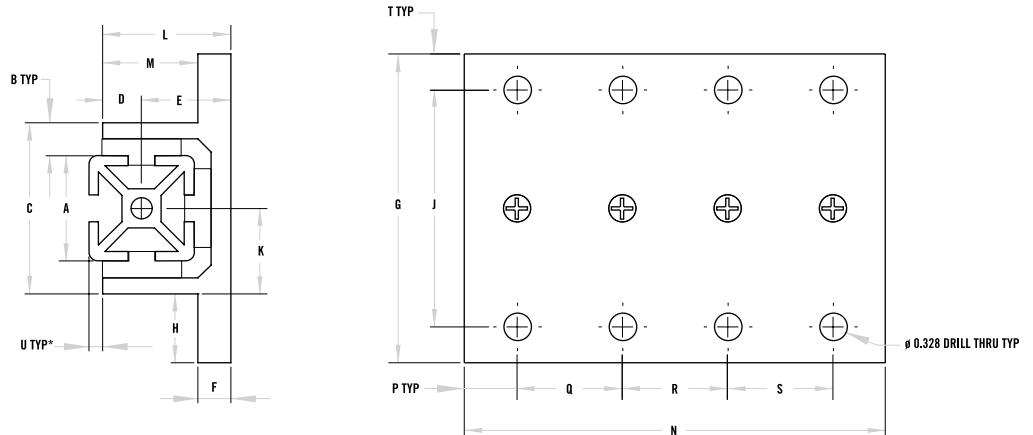

15 SERIES ECONOMY DOUBLEWIDE FLANGE LINEAR BEARINGS ^{15S}



657147



657149

ITEM #	DESCRIPTION
657147	15 Series Economy Short Doublewide Flange Linear Bearing
657149	15 Series Economy Long Doublewide Flange Linear Bearing

RECOMMENDED FASTENERS

651205 5/16-18 x 7/8" SHCS & Economy T-Nut

» See page 08:18 for recommended load ratings.

ITEM #	657147	657149
A	3.00	3.00
B	.500	.500
C	4.00	4.00
D	.640	.640
E	1.235	1.235
F	.375	.375
G	5.50	5.50
H	.750	.750
J	4.75	4.75
K	1.25	1.25
L	1.875	1.875
M	1.50	1.50
N	2.812	6.00
P	.656	.750
Q	1.50	1.50
R	N/A	1.50
S	N/A	1.50
T	.375	.375
U*	.125	.125
V	1.50	1.50

*Add 1.5" when using a 3" x 3" extrusion or 4.5" when using a 3" x 6" extrusion.

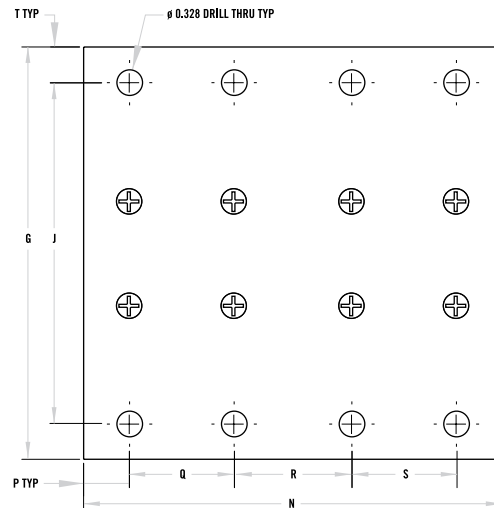
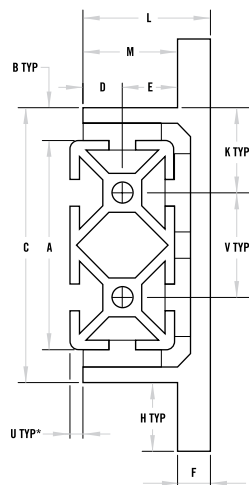

Linear Motion

LINEAR BEARING BRAKE HANDLE KITS



ITEM #	DESCRIPTION
657106	10 Series L-Handle (10S) (25S)
657107	10 Series Hex Nut (10S) (25S)
657108	10 Series Wing Nut (10S) (25S)
657079	15 Series L-Handle (15S)
657080	15 Series T-Handle (15S)
657081	15 Series Star Handle (15S)
657082	15 Series Hex Nut (15S)
657083	15 Series Wing Nut (15S)

*Includes Handle, Stud and Washers

BLACK NYLON ROLLER WHEELS



ITEM #	DESCRIPTION
655222	10 S Economy Roller Wheel (10S) (25S)
655223	10 S To 15 S Economy Roller Wheel (10S) (25S)
655224	15 S Economy Roller Wheel (15S)
655221	15 S Deluxe Roller Wheel (15S)

- Use for guided linear motion
- Mounts to extrusion end or in T-Slot
- Made of high strength black nylatron
- Fasteners included
- 10 and 15 Series sizes
- Economy: brass bushing
- Deluxe: ball bearings

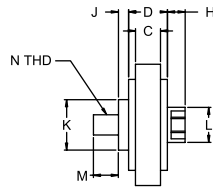
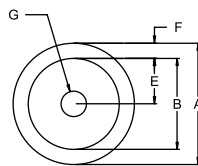
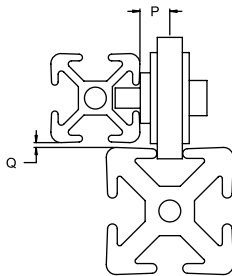

ITEM #	655221	655224	655223	655222
A	2	2	1.5	1.5
B	1.625	1.625	1.125	1.125
C	0.31	0.31	0.31	0.24
D	0.72	0.72	0.48	0.48
E	0.812	0.812	0.563	0.563
F	0.188	0.188	0.188	0.188
G	0.375	0.375	0.314	0.314
H	0.25	0.25	0.219	0.219
J	0.125	0.125	0.125	0.125
K	0.75	0.75	0.625	0.625
L	0.562	0.562	0.435	0.435
M	0.375	0.375	0.31	0.31
N	5/16-18	5/16-18	1/4-20	1/4-20
Q	0.06	0.06	0.06	0.06
P	0.485	0.485	0.37	0.37
*LOAD	100 lbs	75 lbs	75 lbs	50 lbs

*Values are recommended load ratings not to be used for design purposes.

		MOUNTS TO							
		1 x 1	1 x 2	2 x 2	1.5 x 1.5	1.5 x 1.5L	1.5 x 3.0	1.5 x 3.0L	1.5 x 4.5
ROLLS IN	1 x 1	655222							
	1 x 2								
	2 x 2								
	1.5 x 1.5	655223							
	1.5 x 1.5L								
	1.5 x 3.0								
	1.5 x 3.0L								
	1.5 x 4.5								
3 x 3	655221 & 655224								

ROLLER WHEEL BRACKETS AND ASSEMBLIES



- Ideal for framed doors
- Assembly part numbers include roller wheels
- Fasteners included for both assembly and bracket part numbers

ITEM #	DESCRIPTION
655472	1010 Roller Wheel Bracket (10S) (25S)
655473	1010 Roller Wheel Bracket w/ 655222 (10S) (25S)
655474	1020 Roller Wheel Bracket (10S) (25S)
655475	1020 Roller Wheel Bracket w/ 655222 (10S) (25S)
655476	15 S Roller Wheel Bracket (15S)
655477	15 S Roller Wheel Bracket w/ 655221 (15S)
655478	15 S Roller Wheel Bracket w/ 655224 (15S)
655479	15 S Roller Wheel Bracket (15S)
655480	1530 Roller Wheel Bracket w/ 655221 (15S)
655481	1530 Roller Wheel Bracket w/ 655224 (15S)

INCLUDED HARDWARE

QTY	SERIES	DESCRIPTION
2	10 S	1/4-20 x 3/8" LHSCS
2	10 S	1/4-20 Std T-Nut
2	15 S	5/16-18 x 5/8" LHSCS
2	15 S	5/16-18 Std T-Nut

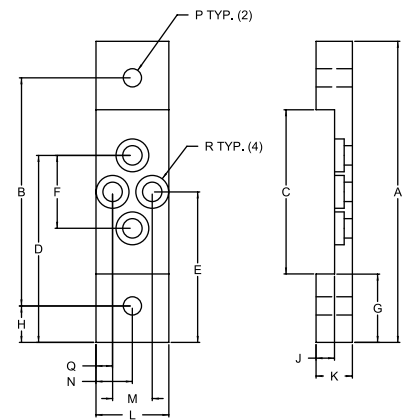

ITEM #	A	B	C	D	E	F	G	H	J	K	L	M	N	Q	P
655472	3.125	2.125	1.25	1.897	1.563	0.669	0.938	0.5	0.255	0.5	1	0.544	0.5	0.228	1/4-20
655474	4.125	3.125	2.25	2.562	2.063	1	0.938	0.5	0.255	0.5	1	0.544	0.5	0.228	1/4-20
655476	4.625	3.125	1.75	2.743	2.313	0.86	1.438	0.75	0.39	0.75	1.5	0.735	0.75	0.383	5/16-18
655479	6.125	4.625	3.25	3.813	3.063	1.5	1.438	0.75	0.39	0.75	1.5	0.735	0.75	0.383	5/16-18

ROLLER WHEEL BRACKETS AND ASSEMBLIES

655473

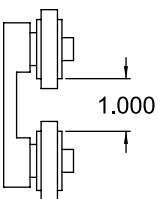

655475

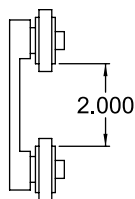

655477

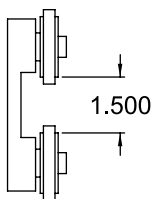

655478

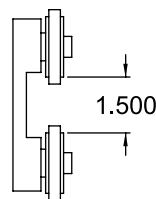

655480

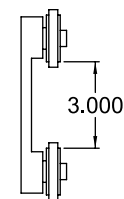

655481

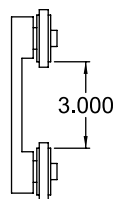

ASSEMBLY PART #	INDIVIDUAL PART NUMBER							
	655472	655474	655476	655479	655222	655223	655221	655224
655473	1				2			
655475		1			2			
655477			1				2	
655480				1			2	
655478			1					2
655481				1				2

Linear Motion

LINEAR BEARING MACHINING SERVICES



ITEM #	DESCRIPTION
660093	10 S Brake Machining Service (.281 Hole) 10S 25S
660092	15 S Brake Machining Service (.328 Hole) 15S

To order linear bearing machining services, specify the linear bearing, the machining service and the brake hole location.

Example - 657095 - 660092 @ C4

» We recommend using Linear Brakes on the side without the set screw if possible.





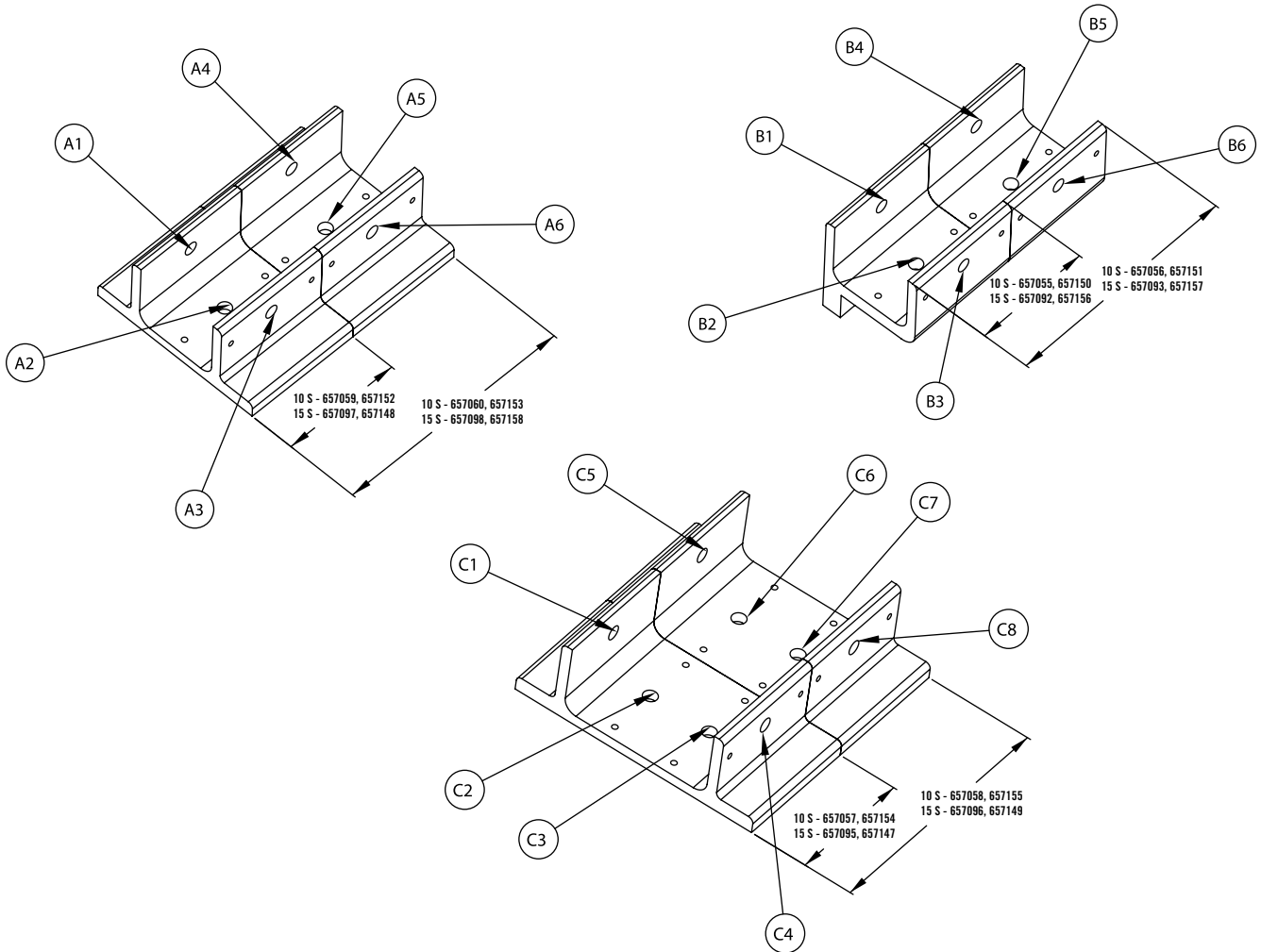

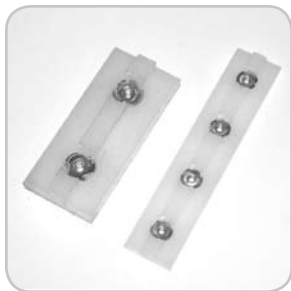

» Refer to linear bearing drawings on pages 8:02 - 8:13 for dimensions.

When ordering linear bearing machining services, make sure the linear bearing and the machining service are both the same series.



LINEAR BEARING REPLACEMENT PADS



ITEM #	DESCRIPTION
657135	10 S Short Keyed Bearing Pad  
657133	10 S Short Flat Bearing Pad  
657136	10 S Long Keyed Bearing Pad  
657134	10 S Long Flat Bearing Pad  
657139	15 S Short Keyed Bearing Pad 
657137	15 S Short Flat Bearing Pad 
657140	15 S Long Keyed Bearing Pad 
657138	15 S Long Flat Bearing Pad 

TSLOTS LINEAR BEARINGS

The shimless linear bearing from Futura Industries provides accurate linear movement on TSLOTS extrusions. The bearing can be adjusted for the first time on an assembly or adjusted for wear while assembled to the application, providing that the adjustment screws are available to the adjustment tools. No shims, no disassembly, only accurate sliding.

1. Linear Bearing adjustable bearing pads are delivered in the open position. Slide the bearing on the extrusion to be used. (Fit will be loose, because of the open position.)
2. Using a 1/16 allen wrench for a 10 Series linear bearing, and a 3/32 allen wrench for 15 Series linear bearing, loosen the Flathead socket cap screws on each side of the linear bearing incrementally as follows. (Fig. #1)

- 10 Series Bearing, 4-40 THREAD
- 15 Series Bearing, 8-32 THREAD

**Each flathead screw should be loosened the same amount, to provide even shimming on the extrusion.*

3. Tighten each set screw, using a .050 allen wrench for a 10 Series linear Bearing, and a 5/64 allen wrench for a 15 Series linear bearing, until each flat head screw is properly seated in each countersink. Hint: The amount of turns per set screw will be the same amount as for the flat head socket cap screw. (Fig. #2)

4. For fine tuning: Repeat steps 2 & 3.

**Replacement bearing pads are available through Futura Industries or your distributor. Due to patent requirements, Futura Industries requires all users of the aforementioned product to only replace bearing pads as per the drawing below. Only the opposing sides have keyed bearing pads. (Fig. #3)*

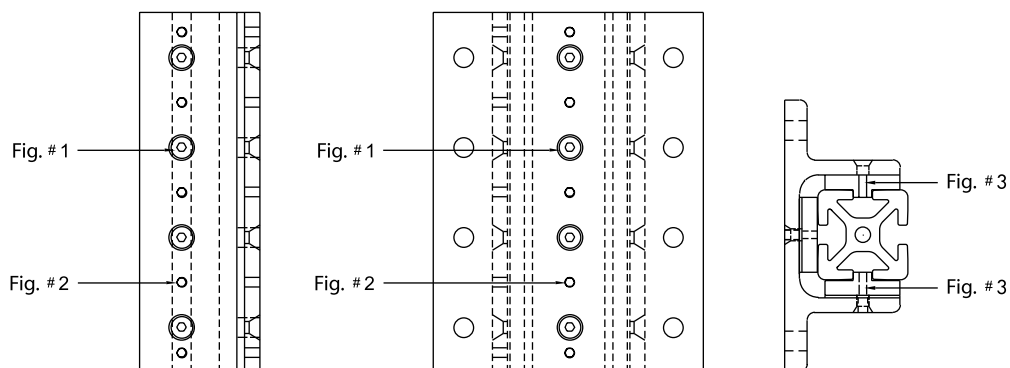

Linear Motion

LINEAR BEARING LOAD RATINGS

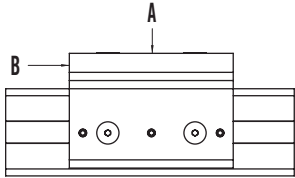

LINEAR BEARING LOAD RATINGS FOR BOTH ECONOMY AND STANDARD BEARINGS

SERIES	LOAD A	FORCE B
10 S	375 lbs	Force to move = 45 lbs
15 S	500 lbs	Force to move = 60 lbs

**Values are recommended load ratings not to be used for design purposes.*

